

User's Manual

TA100

DIGITAL TACHOMETER
and IGNITION ANALYZER

Table of contents.

1. Safety Rules	Page 1
2. Technical Specifications	Page 2
2.1 General specifications	Page 2
2.2 Electrical specifications	Page 2
3. Operation	Page 3
3.1 Instrument description	Page 3
3.2 LCD Display	Page 3
3.3 Buttons description and operation	Page 4
3.4 Measurement procedures	Page 5
3.5 Additional functions	Page 6
4. Application information	Page 7
4.1 Single cylinder RPM measurement	Page 7
4.2 Wireless RPM measurement	Page 8
4.3 Spark plug wire peak voltage measurement	Page 8
5. Maintenance	Page 10
5.1 Battery replacement	Page 10
5.2 Cleaning	Page 10
6. Warranty	Page 10

1. SAFETY RULES

- This instrument is designed for indoor use at temperatures between 32° and 104° F (0°C and 40°C) and altitudes up to 6500 ft. (2,000 meters).
- To ensure that the instrument is used safely, follow all safety and operating instructions in this operation manual. If the instrument is not used as described in this operation manual, the safety features of this instrument may be impaired.
- Do not use the instrument if the instrument, the capacitive pickup or the flexible probe looks damaged, or if you suspect that the instrument is not operating properly.
- When using the instrument, keep away from moving parts (fan, drive belts, etc) and hot objects (exhaust pipes, muffler , catalytic converter, etc), to avoid personal injuries and damage to the instrument, the capacitive pickup or the flexible probe.
- Do not connect or apply more than 42 VDC or any AC current directly to the capacitive pickup or the flexible probe.
- At all times, to avoid electrical shock, use CAUTION when working with electrical circuits above 60V DC or 25V AC rms. Such voltages pose a shock hazard.
- Do not operate this instrument without the holster or the battery cover off.
- To avoid electrical shock or damage to the instrument, do not exceed the specified input limits.

Exceeding the limits listed above when using this apparatus, or not observing the precautions listed above can expose you to physical injury and permanently damage your instrument and/or parts and components of the vehicle under test.

2. TECHNICAL SPECIFICATIONS

2.1 General Specifications

Display:	LCD 4½ digit main measurement, 2 x 3½ digit for maximum and minimum measurements, indicators for low battery, number of cycles, number of cylinders, functions and units.
Update rate:	3 per second (for LCD).
Ignition system comp.:	Conventional, magneto or DIS (distributorless ignition system).
Engine cycles:	2 and 4 cycles and DIS (distributorless ignition system).
Number of cylinders:	1,2,3,4,5,6,8,10 and 12.
Spark plug wire:	Up to 9 mm diameter.
Power:	9 Volt battery, type MN1604.
Auto power off:	Automatically powers off after 1 minute of no operation.
Battery life:	Approximately 25 hours (with alkaline battery).
Probe length:	8" (20 cm) including capacitive pickup.
Dimensions:	6" x 4" x 1.5" (158 x 100 x 37 mm) excluding probe.
Weight:	Approximately. 14 Oz. or 406 g. (Including battery).
Included accessories:	Padded hard carrying case, user's manual, rubber holster and 1 x 9 Volt alkaline battery.

2.2 Electrical Specifications

- The specifications below are typical at 23° C, and will vary slightly from device to device, and with temperature. The input voltage should not exceed the indicated maximum values, to prevent personal injury or damage to the instrument.

Function	Measurement Range	Accuracy/Repetitivity	Input Characteristics
Tachometer	200 to 19999 RPM 2 and 4 cycles and DIS 1,2,3,4,5,6,8,10 and 12 cylinders	Accuracy: 0.1% ± 1 LSD	Input Impedance: 2 MΩ minimum + 1.6 nF (Max). Input Protection: ± 42 VDC Max.
Spark plug wire peak voltage	0 to 50 kVot	Repetitivity: 3% ± 1 LSD	
KV Adjust	KV scale adjustable between 20 and 200%	Default value: 100%	

3. OPERATION

3.1 Instrument Description

- 1) Capacitive pickup
- 2) Flexible probe
- 3) Protective rubber holster
- 4) LCD Display
- 5) Power ON/OFF / Reset button
- 6) Cylinders Increase button
- 7) Engine Cycles / KV Adjust select button
- 8) Cylinders Decrease button
- 9) Function select button

Fig. 1 - Instrument description

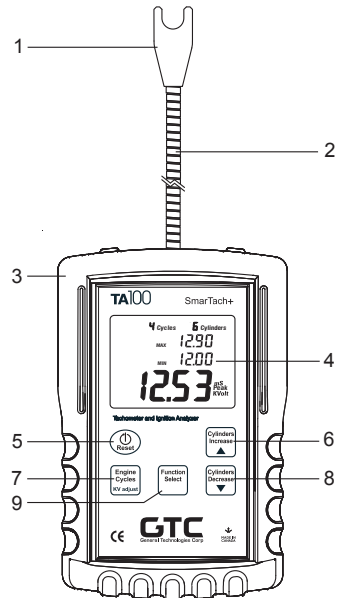

3.2 LCD Display

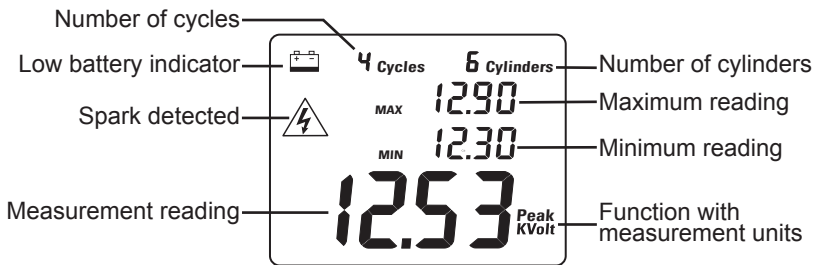

Fig. 2 - LCD Display

3.2.1 LCD Display description



Low battery indicator

- This message warns the battery voltage is below the minimum recommended and it needs to be replaced with a new battery.
- If the battery voltage is low, but still allows for the operation of the instrument, the low battery indicator will turn and stay on until the battery is replaced with a new one.

Note: If the unit turns off immediately after being turned on, it indicates the battery voltage is below the absolute minimum, and the battery should be replaced to prevent malfunction.

MAX - Maximum reading

- Hold and displays the maximum value of the measurements, with the last digit rounded to '0'. The maximum measurement is automatically reset when turning the unit off or manually by momentarily pressing the 'Power On/Off / Reset' button.

MIN - Minimum reading

- Hold and displays the minimum value of the measurements, with the last digit rounded to '0'. The minimum value is automatically reset when turning the unit off or manually by momentarily pressing the 'Power On/Off / Reset' button.

Spark Detected

- A flashing high voltage symbol  indicates that sparks are being detected in the ignition system.

Number of Cycles

- Displays the selected number of cycles: 2, 4 or DIS (Distributor-less or waste spark ignition system).

Number of Cylinders

- Displays the selected number of cylinders: 1, 2, 3, 4, 5, 6, 8, 10 and 12.

Function with measurement units

- The selected function with the measurement unit are displayed as follows:

Display	Function	Measurement units
RPM	Tachometer	RPM (Revolutions per minute)
Peak KVolt	Spark plug wire peak voltage	KVolt (1000 x Volt)

Measurement reading

- Displays the measurement of the selected function.

3.3 Buttons description and operation

3.3.1 Power ON/OFF and Reset



- When the instrument is OFF, to turn it ON press the 'Power ON/OFF / Reset' button until the unit turns on (in approximately 1 second).
- When the instrument is ON, to turn it OFF press and hold the 'Power ON/OFF / Reset' button until the display turns off (in approximately 3 seconds).
- When the instrument is ON, press momentarily the 'Power ON/OFF / Reset' button to reset the maximum and minimum values.

Note: To extend battery life, the TA100 will automatically turn off after 1 minute of being idle (i.e. no button pressed and no input signal). Turning the unit off manually, when not in use will prolong battery life.

3.3.2 Number of cycles / KV Adjust



- Press the 'Engine Cycles / KV Adjust' button to select the number of cycles for the engine under measurement. Each time the button is pressed the number of cycles will change between 2 cycles, 4 cycles, and DIS settings. The selected setting will show on the display.
- Press and hold the 'Engine Cycles / KV Adjust' button for a few seconds to switch the instrument to KV Adjust mode.

3.3.3 Function Select



- Press the 'Function Select' button to select the measurement function. Each time the button is pressed the measurement function will change between RPM (Tachometer) and Peak KVolt (Spark plug wire peak voltage). The selected setting will be shown on the display.

3.3.4 Cylinders Increase and Decrease buttons



- Each time the 'Cylinder Increase' button is pressed, the number of cylinders will be increased, and the selected number of cylinders will be shown on the display.
- When the KV Adjust mode is activated, this button is used to increase the Peak KVolt scale setting.



- Each time the 'Cylinder Decrease' button is pressed, the number of cylinders will be decreased, and the selected number of cylinders will be shown on the display.
- When the KV Adjust mode is activated, this button is used to decrease the Peak KVolt scale setting.





3.4 Measurement Procedures

CAUTION

To avoid personal injuries and damage to the instrument carefully inspect the spark plug wires, distributor cap, ignition coil and all other ignition system parts for damage or leaks, and avoid using this instrument in case any damage or leaks are found. Never touch the capacitive pickup or flexible probe during a test. Wear insulating gloves when working around high voltage, and hot parts, and keep away from moving parts (fan, drive belts, etc) and hot objects (exhaust manifold and pipes, muffler, catalytic converter, etc.)

3.4.1 Tachometer function

3.4.1.1 Single cylinder RPM measurement

- 1-Turn the instrument on.
- 2- Select the number of cycles for the engine under measurement by pressing the  (*Engine Cycles*) button repeatedly until the display shows the correct setting.
- 3- Set the number of cylinders to "1", by pressing the  (Cylinder Increase) or  (Cylinder Decrease) buttons repeatedly until the display shows "1 Cylinder".
- 4- If not already selected, press the  (*Function Select*) button until the display shows RPM.
- 5- Place the capacitive pickup over one of the spark plug wires (See Fig 3).
- 6- Read the RPM on the display.

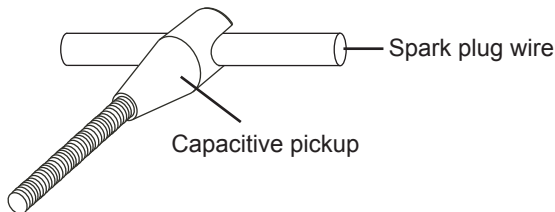







Fig. 3 - Capacitive pickup on spark plug wire for single cylinder RPM and spark plug wire peak voltage measurement.

3.4.1.2 Wireless RPM measurement

- 1-Turn the instrument on.
- 2-Select the number of cycles for the engine under measurement by pressing the  (*Engine Cycles*) button repeatedly until the display shows the correct setting.
- 3-Set the number of cylinders for the engine under measurement by repeatedly pressing the  (*Cylinder Increase*) or  (*Cylinder Decrease*) buttons until the correct number of cylinders is displayed.
- 4- Select the tachometer function by repeatedly pressing the  (*Function Select*) button until the display shows RPM.
- 5- Position the capacitive pickup / flexible probe over the distributor, coil pack or a place where all the spark plug wires run together (in order to receive signals from all the of them at once).
- 6- Adjust the distance between the capacitive pickup/flexible antenna and distributor, coil pack or the spark plug wires until display shows RPM reading.

Note: The optimal distance between the capacitive pickup/flexible probe and distributor, coil pack or spark plug wires, will vary with each ignition system, spark plug wire type and condition, etc., but in general a distance between 2” to 10” will produce reliable readings.

3.4.2 Spark Plug Wire Peak Voltage Measurement

- 1- Turn the instrument on.
- 2- If not already selected, press the  (*Function Select*) button to select the spark plug wire peak voltage function (the display scale will shows “Peak KVolt”).
- 3- Place the capacitive pickup over one of the spark plug wires (as shown in Fig. 3).
- 4- Read the spark plug wire peak voltage on the display.

3.5 Additional functions

3.5.1 Maximum and Minimum functions

The TA100 holds the maximum and minimum values of the measurements for the function currently selected.





- The maximum and minimum values are reset upon turning the TA100 power on, changing function or by momentarily pressing the  (*Power On/Off and Reset*) button.
- For both, the tachometer (RPM) and spark plug wire peak voltage (Peak KVolt) functions, the maximum and minimum values will be shown with the last digit rounded to 0.

3.5.2 KV Adjust function

The TA100 allows the user to adjust the scale used for spark plug wire peak voltage measurements in order to match readings with other instruments (i.e. Ignition Scope).

To use the KV Adjust function:

- 1-Turn the instrument on.
- 2-To perform adjustments of the KV scale while performing actual measurements, select the Peak KVolt function as described in ‘3.4.2 Spark Plug Wire Peak Voltage Measurement’.

- 3- Press and hold the  (*Engine Cycles / KV Adjust*) button until the minimum reading in the display is replaced by 'KV Scale' and then a number followed by a '%' sign, as shown in Fig. 4 below.
- 4- While holding the  (*Engine Cycles / KV Adjust*) button pressed, use the  (*Cylinder Increase*) or  (*Cylinders Decrease*) buttons to adjust the scale value.

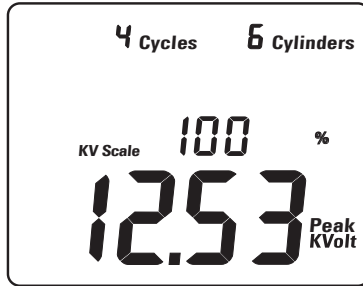

Fig. 4 - Example of display when in KV Adjust mode

Notes:

- By adjusting the Peak KVolt scale while performing spark plug wire peak voltage measurements, it is simpler and easier to evaluate the changes and/or matching other instruments readings.
- The scale can be adjusted between 20% and 200% of the factory calibration value (i.e. 100% factory value).
- For example, if KV Adjust is set to 50%, the spark plug wire peak voltage shown will be half (or 50%) of the value shown when using the factory default setting.
- The values set by using the KV Adjust function are stored in a permanent internal memory, and will be retained even if the instrument is powered off, the battery is depleted or is removed.

4. APPLICATION INFORMATION

4.1 Single cylinder RPM measurement

This function allows to measure RPM by using the capacitive pick up in a single spark plug wire, in cases when it is difficult or not possible to position the TA100's antenna in a place where it can receive signals simultaneously from all the spark plug wires.

A few examples of where to use single cylinder RPM measurement are:

- Single cylinder engines.
- Engines with two banks of cylinders using one distributor and ignition coil for each bank.
- Spark plug wires, distributor, and ignition coil partially or totally shielded by metal parts.

Note: In order to obtain the correct RPM reading, insure the number of cycles is set to match the cycles of the engine under measurement, and the number of cylinders is set to '1' (for details on how to enter these setting see section '3.4.1.1 Single cylinder RPM measurement').

4.2 Wireless RPM measurement

This function allows to measure RPM without contact with any spark plug wire or any other part of the engine, allowing quick and safe RPM measurement from a convenient location.

- 1-Follow the procedure described in section '3.4.1.2 Wireless RPM measurement', and hold the SmarTach+ by its rubber holster. Do not touch the capacitive pickup or flexible probe .
- 2-Place the flexible probe near (but without touching) a place where the spark plug wires are grouped together, like a distributor cap, coil packs, etc. After a brief moment the display should start showing the RPM of the engine.
- 3-If a different position of the instrument is required, move the flexible probe slowly away from its position, while insuring the instrument is providing an steady RPM reading. If you do move the flexible probe too quickly, the instrument will be unable to adjust to the rapid changes, and it may not provide steady readings if any at all.
- 4-After obtaining the first reading, you may want to continue to move the flexible probe further away, in order to locate the SmarTach+ in a more comfortable position or to a convenient resting place (e.g. air filter, etc.). If while doing it, the display starts to show "0", then you have moved the flexible probe to a distance or place in which the signal has become too weak to be detected by the instrument. Try moving the flexible probe closer to the ignition system or rotating the SmarTach+, until the RPM reading is reestablish.

Notes:

- In special cases where the ignition system is partially shielded by metal parts, the working range of the SmarTach+ will diminish, and it may be necessary to move the SmarTach+ flexible probe closer to the spark plug wires to obtain a reading.
- If the flexible probe is placed too close to the one of the spark plug wires, this individual single spark plug wire signal may overtake (in strength) the signals from the other spark plug wires, and the SmarTach+ will show the RPM divided by the number of cylinders selected. This situation can be easily rectified by moving the flexible probe to another location or setting the number of cylinders to '1' in the SmarTach+.
- If you decide to lay the SmarTach+ down on a nearby resting place to have both hands free to make adjustments, make sure that the capacitive pickup and flexible probe is not touching any metal part and that engine vibrations cannot cause the SmarTach+ to move or fall.

4.3 Spark Plug Wire Peak Voltage Measurement

In addition to its primary function as a tachometer, the SmarTach+, has the capability to indicate the relative strength of the spark plug wires peak voltage.

Checking the ignition system

- 1-Select the spark plug wire peak voltage function by following the procedures in '3.4.2 Spark Plug Wire Peak Voltage Measurement'.
- 2-The end of the flexible probe is provided with a special capacitive pickup with a groove, designed so the spark plug wire is placed inside it. This capacitive pickup can be rotated on the flexible probe to easily adjust to a convenient position. Place this capacitive pickup over the spark plug wire, as near as possible to the spark plug, pressing gently on the spark plug wire, while maintaining a right angle between the capacitive pickup and the spark plug wire

- 3-Observe the ignition peak voltage reading of the display. Some jumping of the readings is normal and reflects actual changes in the peak voltages of the ignition system.
- 4-Record or memorize the maximum, minimum and average reading. Repeat the test for each of the spark plug wires of the engine and note any readings that are significantly higher or lower than the average.
- 5-Ignition problems may sometimes appear at higher engine RPM, but not at low or idle speed. We recommend that measurements be made at idle speed and normal engine operating temperature, and then at increasing RPM, and up to equivalent of highway speeds, typically about 2000 to 2500 RPM. Do not exceed maximum permissible (“red-line”) engine speeds. Make all measurements at about the same engine speeds, using the TA100 tachometer function to check the RPM..

4.3.1 Diagnostic using the spark plug wire peak voltage

Small variations of up to 25% in the spark plug wire peak voltage from cylinder to cylinder are normal, and do not necessarily indicate any problem. The placement of the pickup along the spark plug wire will also cause some difference in the readings, due to the internal resistance (or impedance) of the spark plug wire. For example, if the pickup is placed on the spark wire near the distributor or DIS coil, voltage readings will be higher than if the pickup is placed near the spark plug.

For diagnostic purposes, the attention should be focused on SIGNIFICANT DIFFERENCES in readings caused by problems in the engine or the ignition system itself.

Common Causes of Low Voltage Readings

- Shorted, dirty or too small spark plug gap.
- Dirty or damaged spark plug insulator boot allowing spark “tracking” across insulator.
- Broken core in spark plug wire. Break is located between the distributor (or DIS coil) and the test point.
- Short circuit, disconnection or partial disconnection between the distributor (or DIS coil) and spark plug wire.
- Rich mixture. Most likely due to leaking fuel injector, or faulty oxygen sensor.
- Low cylinder compression pressure. Could be caused by leaking valve(s), worn piston rings, blown cylinder head gasket, etc.

Common Causes of High Voltage Readings

- Spark plug gap too wide.
- Spark plug wire connector damaged, loose or disconnected.
- Broken core in spark plug wire. Break is located between the spark plug and the test point.
- Lean mixture.

5. MAINTENANCE

2.1 Battery replacement

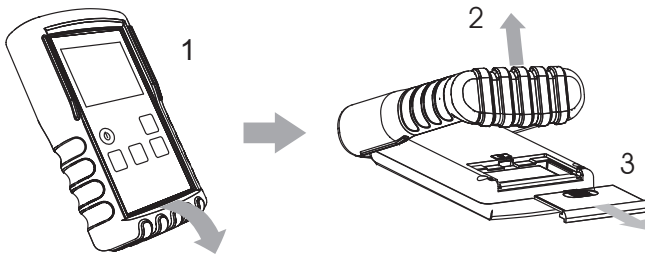

Fig 5 - Battery replacement

- 1-Release the rubber holster from plastic enclosure by pulling from the bottom of the holster as shown in the illustration (Fig. 5)
- 2-Push the rubber holster forward until the battery compartment cover is exposed
- 3-Slide open battery cover located at the back of the unit.
- 4-Connect the new battery observing the polarity of the battery connectors.
- 5-Replace battery cover and rubber holster.
- 4-Press the Power On/Off / Reset button on the TA100 until the display turns on. If the display does not turn on, check the battery polarity and reinstall if necessary. To turn the unit off, press and hold the Power On/Off / Reset button again until the display turns off.

5.2 Cleaning

Keep the instrument in its carrying case when not in use and do not subject it to dampness or severe heat or cold. Do not use the instrument in the rain, if it should accidentally get wet, dry it off with a clean paper towel before storing it away.

Protect the unit from contact with any solvents. Never clean with a solvent or petroleum based medium such as gasoline, as these chemicals may attack the plastic parts and cause permanent damage. Never use an abrasive cleaner. Cleaning should be limited to wiping with a clean damp paper towel and a small amount of soap if required. Dry the unit thoroughly after any cleaning.

The unit is a sealed instrument and contains no user serviceable parts other than the battery, which can be replaced by opening the drawer on the back of the unit. Opening other parts of the unit will void the warranty.

6. WARRANTY

With the exception of the battery, this instrument is warranted against defects of material and workmanship which develop within a period of one (1) year following the date of purchase by the original owner. For details see Standard Warranty Information on our web page at www.gtc.ca or you may request a printed copy.

To visit our website, scan the QR code below with your smart phone.



Or type this URL in your browser:

www.gtc.ca

GTC
General Technologies Corp

#121 - 7350 72nd Street
Delta, BC
Canada V4G 1H9

Tel: (604) 952-6699
Fax: (604) 952-6690
email: info@gtc.ca